

# Panasonic

## Quick Reference Guide

---

### Digital Proprietary Telephone

Model No. **KX-DT521/KX-DT543/KX-DT546**

### Digital DSS Console

Model No. **KX-DT590**

Thank you for purchasing a Digital Proprietary Telephone (DPT). Please read this manual carefully before using this product and save this manual for future use. For more details, please refer to the manuals of the PBX.

#### **This product supports the following PBX versions and CODEC types:**

- KX-NS1000: PCMPR Software File Version 3.1000 or later
- KX-NCP500/KX-NCP1000: PBMPR Software File Version 8.0100 or later
- KX-TDE100/KX-TDE200: PMMPR Software File Version 8.0100 or later
- KX-TDE600: PGMPR Software File Version 8.0100 or later
- KX-TDA30\*1: PSMMPR Software File Version 5.0100 or later
- KX-TDA50\*2: PSMMPR Software File Version 6.0100 or later
- CODEC: G.711

\*1 For Canada only

\*2 For the United States only

#### **Note**

- In this manual, the suffix of each model number is omitted unless necessary.
- The illustrations may differ from the appearance of the actual product.

# **Important Information**

## **WARNING**

Disconnect the telephone line cord from this product if this product emits smoke, an abnormal smell, or makes unusual noise. These conditions can cause fire or electric shock. Confirm that smoke has stopped and contact an authorized service center.

## **CAUTION**

To prevent damage to the telephone, be sure to unplug the extension line before you set up or remove the KX-DT590 (Digital DSS Console).

---

## **FCC and Other Information**

This equipment has been tested and found to comply with the limits for a Class B digital device, pursuant to Part 15 of the FCC Rules. These limits are designed to provide reasonable protection against harmful interference in a residential installation. This equipment generates, uses, and can radiate radio frequency energy and, if not installed and used in accordance with the instructions, may cause harmful interference to radio communications. However, there is no guarantee that interference will not occur in a particular installation. If this equipment does cause harmful interference to radio or television reception, which can be determined by turning the equipment off and on, the user is encouraged to try to correct the interference by one or more of the following measures:

- Reorient or relocate the receiving antenna.
- Increase the separation between the equipment and receiver.
- Connect the equipment into an outlet on a circuit different from that to which the receiver is connected.
- Consult the dealer or an experienced radio/TV technician for help.

## **CAUTION**

Any changes or modifications not expressly approved by the party responsible for compliance could void the user's authority to operate this device.

### **WHEN PROGRAMMING EMERGENCY NUMBERS AND (OR) MAKING TEST CALLS TO EMERGENCY NUMBERS:**

- a. Remain on the line and briefly explain to the dispatcher the reason for the call.
- b. Perform such activities in the off-peak hours, such as early morning or late evenings.

This equipment is hearing aid compatible.

When you hold the phone to your ear, noise might be heard in your Hearing Aid. Some Hearing Aids are not adequately shielded from external RF (radio frequency) energy. If noise occurs, use the speakerphone option (if applicable) when using this phone. Consult with your audiologist or Hearing Aid manufacturer about the availability of Hearing Aids which provide adequate shielding to RF energy commonly emitted by digital devices.

### **For users in Canada only**

- This Class B digital apparatus complies with Canadian ICES-003.
- This product meets the applicable Industry Canada technical specifications.

### **Compliance with TIA-1083 standard:**





Telephone handsets identified with this logo have reduced noise and interference when used with T-Coil equipped hearing aids and cochlear implants.



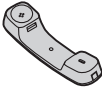

# Accessory Information

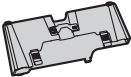
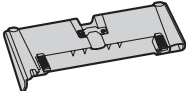
## Included Accessories

KX-DT521/KX-DT543/KX-DT546

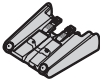
Handset (1)	Handset Cord (1)	Telephone Line Cord (1)
		
<b>Stand (1)</b>		
KX-DT521 	KX-DT543 KX-DT546 	

KX-DT590

Stand (1)	Telephone Line Cord (1)	Wall mounting adaptor (1)
		
<b>Screws for wall mounting (3)*1</b>		<b>Screws for attaching to the unit (2)</b>
		

\*1 Two screws for attaching the KX-DT590 to a wall.  
One screw for attaching the wall mounting adaptor to the unit.

### Note

For extra orders for the accessories, call toll-free: 1-800-332-5368. (For users in the United States only)

**Optional Accessories**

	<b>KX-DT521</b>	<b>KX-DT543</b>	<b>KX-DT546</b>
<b>Wall mount kit</b>	KX-A432	KX-A433	
<b>Digital DSS Console</b>	KX-DT590		

# Location of Controls

KX-DT521

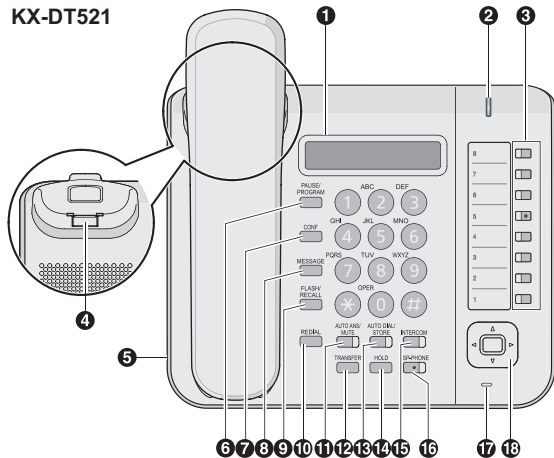

**KX-DT543  
KX-DT546**

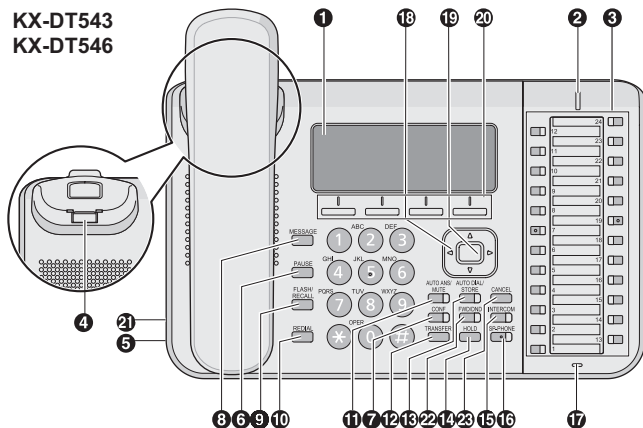

**KX-DT590**

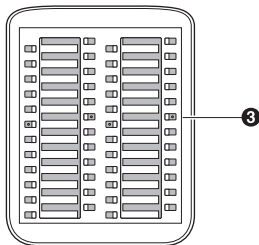

- 1 LCD (Liquid Crystal Display):**  
KX-DT521: 1 line, KX-DT543: 3 lines, KX-DT546: 6 lines
- 2 Message/Ringer Lamp:**  
When you receive an intercom call, the lamp flashes green, and on an outside call, the lamp flashes red. When someone has left you a message, the lamp stays on red.
- 3 Flexible CO Buttons:** Used to seize an outside line or perform a feature that has been assigned to the key.

## ***Location of Controls***

---

- ④ **Handset Hook:** Keeps the handset stable when the unit is mounted on a wall.
- ⑤ **Headset Jack**
- ⑥ **PAUSE/PROGRAM** (KX-DT521 only): Used to insert a pause when storing a telephone number. This button is also used for programming this unit.  
**PAUSE** (KX-DT543/KX-DT546 only): Used to insert a pause when storing a telephone number.
- ⑦ **CONF:** Used to establish a multiple party conversation.
- ⑧ **MESSAGE:** Used to leave a message waiting indication or call back the party who left the message waiting indication.
- ⑨ **FLASH/RECALL:** Used to disconnect the current call and make another call without hanging up.
- ⑩ **REDIAL:** Used to redial the last dialed number.
- ⑪ **AUTO ANS/MUTE:** Used to receive an incoming call in hands-free mode or mute the microphone/handset during a conversation.
- ⑫ **TRANSFER:** Used to transfer a call to another party.
- ⑬ **AUTO DIAL/STORE:** Used for System/Personal Speed Dialing or storing programme changes.
- ⑭ **HOLD:** Used to place a call on hold.
- ⑮ **INTERCOM:** Used to make or receive intercom calls.
- ⑯ **SP-PHONE (Speakerphone):** Used for performing hands-free operations.
- ⑰ **Microphone:** Used for hands free conversations.
- ⑱ **Navigator Key:** Used to adjust the volume and the display contrast or select desired items.
- ⑲ **ENTER\*1:** Used to assign the selected item.
- ⑳ **Soft Buttons (S1-S4)\*1:** S1-S4 (located from left to right) are used to select the item displayed on the bottom line of the display.



- ⑳ **EHS (Electronics Hook Switch) Jack**<sup>\*1</sup>
- ㉑ **FWD/DND**<sup>\*1</sup>: Used to switch Call Forwarding or Do Not Disturb on your extension.
- ㉒ **CANCEL**<sup>\*1</sup>: Used to cancel the selected item.

\*1 KX-DT543/KX-DT546 only

## Before Operating the Telephone

### Speaker volume

While in a hands-free conversation  
Press [▲] or [▼] to adjust the volume.

### Handset/Headset volume\*1

While using the handset or headset  
Press [▲] or [▼] to adjust the volume.

### Ringer volume

While on-hook or receiving a call  
Press [▲] or [▼] to adjust the volume.

### LCD Contrast

While on-hook

1. Press the **PROG** soft button (S1).\*2
2. Enter 0①.
3. Press [ENTER].\*3
4. Press [▲] or [▼] to adjust the LCD contrast.
5. Press [ENTER].\*3
6. Press [CANCEL].\*2

### Ring Tone

1. Press the **PROG** soft button (S1).\*2
2. Press a flexible CO button or [INTERCOM] 2 times.
3. Enter 2 digits (01-30) using the dial keys (0-9), or press [▲] or [▼] to select the ring tone.
4. Press [ENTER].\*3
5. Press [CANCEL].\*2

\*1 If you hear your own voice through the handset or headset, decrease the volume.

\*2 For KX-DT521, press [PAUSE/PROGRAM].

\*3 For KX-DT521, press [AUTO DIAL/STORE].

### LCD Backlight

While on-hook

1. Press the **PROG** soft button (S1).<sup>\*1</sup>
2. Enter ①④.
3. Press [ENTER].<sup>\*2</sup>
4. Press a dial key to select the LCD backlight mode.  
①: Automatic  
①: Always ON  
②: Always OFF
5. Press [ENTER].<sup>\*2</sup>
6. Press [CANCEL].<sup>\*1</sup>

<sup>\*1</sup> For KX-DT521, press [PAUSE/PROGRAM].

<sup>\*2</sup> For KX-DT521, press [AUTO DIAL/STORE].

## Feature Operations

---

### Making Calls

#### Calling

##### **[To an extension]**

1. Go off-hook.
2. Dial an extension number.

##### **[To an outside party]**

1. Go off-hook.
2. Press a flexible CO button.
3. Dial the outside party's phone number.

#### Redial

1. Go off-hook.
2. Press [REDIAL].

#### Quick Dialing

1. Go off-hook.
2. Dial a quick dialing number.

#### Doorphone Call

1. Go off-hook.
2. Enter \*31.
3. Enter a doorphone number (2 digits).
4. After the confirmation tone, talk.

#### System Speed Dialing

1. Go off-hook.
2. Press [AUTO DIAL/STORE].
3. Enter a system speed dialing number (3 digits).

### Personal Speed Dialing

#### **[To store]**

1. Go off-hook.
2. Enter **\*30**.
3. Enter a personal speed dialing number (2 digits).
4. Enter the phone number to store (max. 32 digits).<sup>\*1</sup>
5. Press **#**.
6. After the confirmation tone, go on-hook.

#### **[To dial]**

1. Go off-hook.
2. Press [AUTO DIAL/STORE].
3. Enter **\***.
4. Enter a personal speed dialing number (2 digits).

### One-touch Dialing

#### **[To store]**

1. Press the **PROG** soft button (S1).<sup>\*2</sup>
2. Press a flexible CO button.
3. Enter **2**.
4. Enter the number to store (max. 32 digits).<sup>\*1</sup>
5. Press [ENTER].<sup>\*3</sup>
6. Press [CANCEL].<sup>\*2</sup>

#### **[To dial]**

1. Go off-hook.
2. Press the flexible CO button assigned as a One-touch Dialing button.

<sup>\*1</sup> Enter the outside line access number before an outside phone number.

<sup>\*2</sup> For KX-DT521, press [PAUSE/PROGRAM].

<sup>\*3</sup> For KX-DT521, press [AUTO DIAL/STORE].

### During a Conversation

#### Call Hold

**[To hold]**

1. Press [HOLD].
2. After the confirmation tone, go on-hook.

**[To retrieve a call at the holding extension]**

1. Go off-hook.
2. Press a flexible CO button or [INTERCOM].

**[To retrieve an outside call from another extension]**

1. Go off-hook.
2. Press a flexible CO button.

#### Call Transfer

**[To an extension]**

1. Press [TRANSFER].
2. After the confirmation tone, dial an extension number.
3. Talk.
4. Go on-hook.

**[To an outside party]**

1. Press [TRANSFER].
2. After the confirmation tone, press a flexible CO button.
3. Dial an outside phone number.
4. Talk.
5. Go on-hook.

## Setting the Telephone According to Your Needs

### Do Not Disturb

1. Go off-hook.
2. Enter \*71.
3. Press a dial key to select the setting.  
0: Both outside and intercom calls  
1: Outside calls only  
2: Intercom calls only
4. To enable Do Not Disturb, enter 1.  
To cancel Do Not Disturb, enter 0.
5. After the confirmation tone, go on-hook.

### Timed Reminder

#### **[To set]**

1. Go off-hook.
2. Enter \*7601.
3. Enter the hour and minute (4 digits).
4. If 12-hour-time display is set, enter 0 (AM) or 1 (PM).
5. Enter 0 (1 time) or 1 (daily).
6. After the confirmation tone, go on-hook.

#### **[To cancel]**

1. Go off-hook.
2. Enter \*7600.
3. After the confirmation tone, go on-hook.

#### **[To stop or answer the ring back]**

1. Press [INTERCOM], or go off-hook.

### Useful Features

#### Multiple Party Conversation

##### **[To add other parties during a conversation]**

1. Press [CONF].
2. After the confirmation tone, dial the phone number of the party to add.
3. Talk to the new party.
4. Press [CONF].
5. After the confirmation tone, talk with multiple parties.

##### **[To leave a conference]**

1. Press [CONF].
2. After the confirmation tone, go on-hook.

---

### Before Leaving Your Desk

#### Call Forwarding

1. Go off-hook.
2. Enter \*7①.
3. Press a dial key to select the types of calls to apply this feature to.  
①: Both outside and intercom calls  
②: Outside calls only  
③: Intercom calls only
4. Press a dial key to select the status.  
④: All calls  
⑤: Busy  
⑥: No answer  
⑦: Busy/No answer  
⑧: Cancel\*1
5. Enter an extension number, and then enter #, or enter a CO line access number, an outside phone number, and then enter #.
6. After the confirmation tone, go on-hook.

\*1 If you enter ⑧ in Step 4, you can skip Step 5.



## Installation and Setup

### Note

- Panasonic assumes no responsibility for injuries or property damage resulting from failures arising out of improper installation or operation inconsistent with this documentation.

### Attaching a KX-DT590 to the KX-DT543/KX-DT546

The KX-DT590 allows 48 additional Flexible CO buttons to be added to this unit. These buttons are used to seize an outside line, make a call using One-touch Dialing, or perform a feature that has been assigned to the key.



- 1 Attach the KX-DT590 to your unit with the 2 screws.\*1

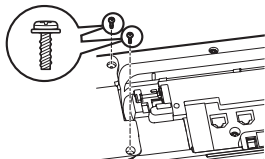

\*1 Included with the KX-DT590.

### Attaching the Stand

#### KX-DT521

- 1 Insert the catches of the stand into the hooks located in the unit.
- 2 Gently push the stand in the direction indicated until it locks into place. The stand will be mounted.

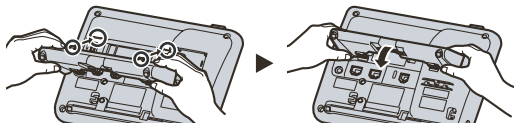

## Installation and Setup

---

### KX-DT543/KX-DT546/KX-DT590

- 1 Insert the catches (A) of the stand into hooks located in the unit.
- 2 Gently push the stand in the direction indicated until it locks into place. The stand will be mounted in the high position.

**Example: KX-DT546**

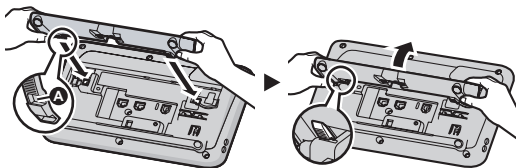

---

## Removing the Stand

### KX-DT521

- 1 Remove the stand in the direction indicated while pushing the catches of the stand with both hands as shown.

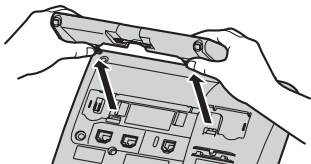

### KX-DT543/KX-DT546/KX-DT590

- 1 Hold the stand with both hands.
- 2 Gently rotate the stand in the direction indicated until it is released.

**Example: KX-DT546**

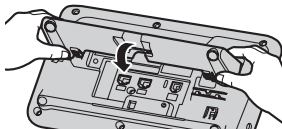

## Connections

### KX-DT521

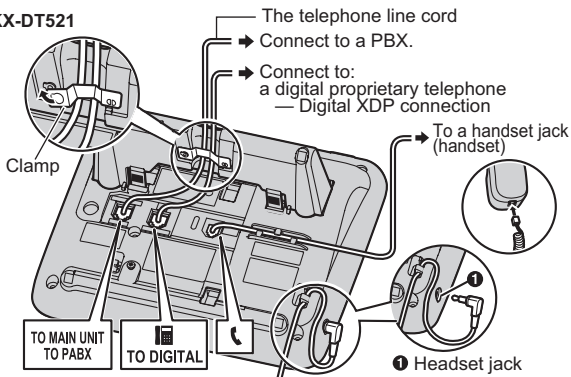

### KX-DT543/KX-DT546

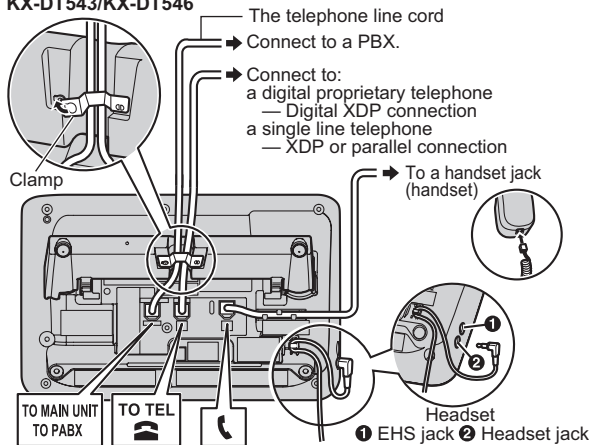

### KX-DT590

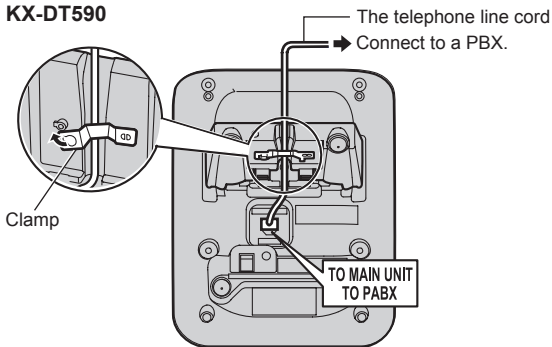

### Note

- **When connecting a headset**

The following headsets can be used with this unit. (Not all operations with the headsets can be guaranteed.)

- Wired headsets

Panasonic KX-TCA400 or KX-TCA430

- EHS headsets (KX-DT543/KX-DT546 only)

For up-to-date information about headsets that have been tested with this unit, please contact your dealer.

<http://panasonic.net/pcc/support/pbx/>

- **When connecting cords**

Ensure the cords are inserted in the grooves, and are clamped to prevent damage to the connectors.

## Wall Mounting

### Note

- When mounting the KX-DT543/KX-DT546 with a KX-DT590 on the wall, attach the KX-DT590 to the KX-DT543/KX-DT546 first, and then mount them on the wall. For detail about the attaching, see “Attaching a KX-DT590 to the KX-DT543/KX-DT546”, Page 17.
- When mounting the KX-DT543/KX-DT546 with a KX-DT590 on a wall, only ONE KX-DT590 can be attached.

- 1 Insert the tabs of the wall mounting adaptor into the designated openings in the base, and then slide the wall mounting adaptor in the direction of the arrow until it clicks.

### KX-DT521

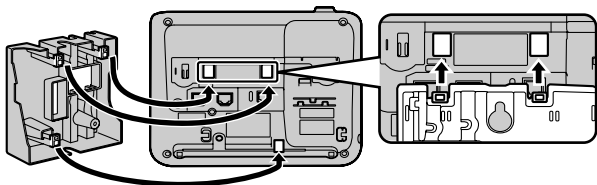

### KX-DT543/KX-DT546 with KX-DT590

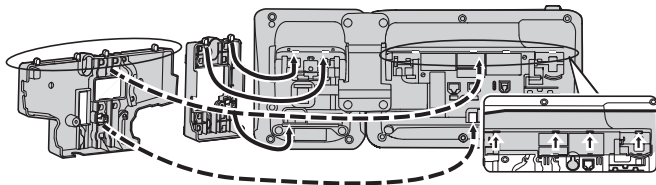

## Wall Mounting

- Fasten the wall mounting adaptor(s) to the base with the screw(s). (Recommended torque: 0.4 N·m [4.08 kgf·cm/3.54 lbf·in] to 0.6 N·m [6.12 kgf·cm/5.31 lbf·in])
- Connect the cables to the unit, and run the cables through the wall mounting adaptor, as shown in the illustration below.
- Drive the screws into the wall either 83 mm (3 1/4 in) or 100 mm (3 15/16 in) apart, and mount the unit on the wall.

### Example: KX-DT543/KX-DT546 with KX-DT590

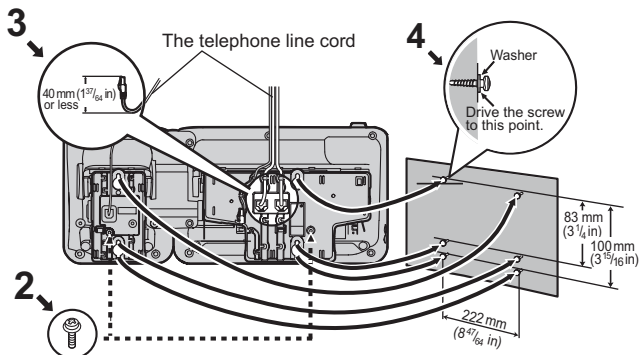



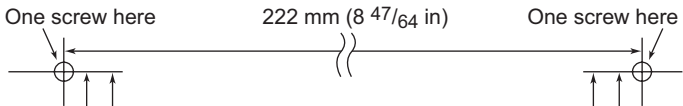

## WALL MOUNTING TEMPLATE

1. Drive the screws into the wall as indicated.
2. Hook the unit onto the screw heads.

### Note:

- If the KX-DT590 is mounted beside a KX-DT543/KX-DT546, leave 222 mm (8  $\frac{47}{64}$  in) of space between the 2 screws for the DPT and the 2 screws for the KX-DT590, as indicated above. This space is abbreviated in this template and must be measured.

100 mm (3  $\frac{15}{16}$  in)  
 83 mm (3  $\frac{1}{4}$  in)  
 for KX-DT521/KX-DT543/KX-DT546

100 mm (3  $\frac{15}{16}$  in)  
 83 mm (3  $\frac{1}{4}$  in)  
 for KX-DT590

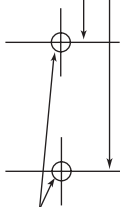

One screw at either point

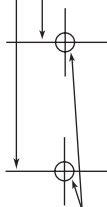

One screw at either point